

FLUKE®

Fluke 123

Industrial ScopeMeter

Users Manual

4822 872 00743

January 1997, Rev. 4, 7/99

© 1997, 1999 Fluke Corporation. All rights reserved. Printed in the Netherlands.
All product names are trademarks of their respective companies.

LIMITED WARRANTY & LIMITATION OF LIABILITY

Each Fluke product is warranted to be free from defects in material and workmanship under normal use and service. The warranty period is three years and begins on the date of shipment. Parts, product repairs and services are warranted for 90 days. This warranty extends only to the original buyer or end-user customer of a Fluke authorized reseller, and does not apply to fuses, disposable batteries or to any product which, in Fluke's opinion, has been misused, altered, neglected or damaged by accident or abnormal conditions of operation or handling. Fluke warrants that software will operate substantially in accordance with its functional specifications for 90 days and that it has been properly recorded on non-defective media. Fluke does not warrant that software will be error free or operate without interruption.

Fluke authorized resellers shall extend this warranty on new and unused products to end-user customers only but have no authority to extend a greater or different warranty on behalf of Fluke. Warranty support is available if product is purchased through a Fluke authorized sales outlet or Buyer has paid the applicable international price. Fluke reserves the right to invoice Buyer for importation costs of repair/replacement parts when product purchased in one country is submitted for repair in another country.

Fluke's warranty obligation is limited, at Fluke's option, to refund of the purchase price, free of charge repair, or replacement of a defective product which is returned to a Fluke authorized service center within the warranty period.

To obtain warranty service, contact your nearest Fluke authorized service center or send the product, with a description of the difficulty, postage and insurance prepaid (FOB Destination), to the nearest Fluke authorized service center. Fluke assumes no risk for damage in transit. Following warranty repair, the product will be returned to Buyer, transportation prepaid (FOB Destination). If Fluke determines that the failure was caused by misuse, alteration, accident or abnormal condition of operation or handling, Fluke will provide an estimate of repair costs and obtain authorization before commencing the work. Following repair, the product will be returned to the Buyer transportation prepaid and the Buyer will be billed for the repair and return transportation charges (FOB Shipping Point).

THIS WARRANTY IS BUYER'S SOLE AND EXCLUSIVE REMEDY AND IS IN LIEU OF ALL OTHER WARRANTIES, EXPRESS OR IMPLIED, INCLUDING BUT NOT LIMITED TO ANY IMPLIED WARRANTY OF MERCHANTABILITY OR FITNESS FOR A PARTICULAR PURPOSE. FLUKE SHALL NOT BE LIABLE FOR ANY SPECIAL, INDIRECT, INCIDENTAL OR CONSEQUENTIAL DAMAGES OR LOSSES, INCLUDING LOSS OF DATA, WHETHER ARISING FROM BREACH OF WARRANTY OR BASED ON CONTRACT, TORT, RELIANCE OR ANY OTHER THEORY.

Since some countries or states do not allow limitation of the term of an implied warranty, or exclusion or limitation of incidental or consequential damages, the limitations and exclusions of this warranty may not apply to every buyer. If any provision of this Warranty is held invalid or unenforceable by a court of competent jurisdiction, such holding will not affect the validity or enforceability of any other provision.

Fluke Corporation, P.O. Box 9090, Everett, WA 98206-9090 USA, or

Fluke Industrial B.V., P.O. Box 680, 7600 AR, Almelo, The Netherlands

SERVICE CENTERS

To locate an authorized service center, visit us on the World Wide Web:

<http://www.fluke.com>

or call Fluke using any of the phone numbers listed below:

+1-888-993-5853 in U.S.A. and Canada

+31-402-678-200 in Europe

+1-425-356-5500 from other countries

Table of Contents

Chapter	Title	Page
	Declaration of Conformity	1
	Unpacking the Test Tool Kit	2
	Safely Using the Test Tool	4
1	Using The Test Tool	7
	Goal of this Chapter.....	7
	Powering the Test Tool.....	7
	Resetting the Test Tool	8
	Changing Backlight.....	9
	Reading the Screen.....	10
	Making Selections in a Menu.....	11
	Looking at the Measurement Connections	12
	Input A	12
	Input B	12
	COM	12

Displaying an Unknown Signal with Connect-and-View™	13
Making Measurements	14
Freezing the Screen	16
Holding a Stable Reading	16
Making Relative Measurements	17
Selecting Auto/Manual Ranges	18
Changing the Graphic Representation on the Screen	18
Changing the Amplitude	18
Changing the Time Base	18
Positioning the Waveform on the Screen	19
Smoothing the Waveform	20
Displaying the Envelope of a Waveform	21
TrendPlotting a Waveform	22
Starting a TrendPlot™ function	22
Changing the TrendPlot Reading	23
Turning Off the TrendPlot Display	23
Acquiring the Waveform	23
Making a Single Acquisition	23
Recording Slow Signals over a Long Period of Time	25
Selecting AC-Coupling	26
Reversing the Polarity of the Displayed Waveform	26
Triggering on a Waveform	27
Setting Trigger Level and Slope	27
Selecting the Trigger Parameters	28
Isolated Triggering	29
Triggering on Video Signals	29

	Triggering on a Specific Video Line	31
	Saving and Recalling a Setup or a Screen	32
	Saving Screens.....	32
	Recalling Screens.....	33
	Deleting Screens	33
	Using a Printer.....	34
	Using FlukeView® Software	36
2	Maintaining the Test Tool	37
	About this Chapter.....	37
	Cleaning the Test Tool	37
	Storing the Test Tool	37
	Charging the Ni-Cd Battery Pack	38
	Keeping Batteries in Optimal Condition	39
	Replacing and Disposing of the Ni-Cd Battery Pack	40
	Using and Adjusting 10:1 Scope Probes	41
	Calibrating the Test Tool	43
	Parts and Accessories.....	43
	Service Manual.....	43
	Standard Accessories.....	43
	Optional Accessories.....	46
3	Tips and Troubleshooting	47
	Goal of this Chapter.....	47
	Using the Tilt Stand	47
	Resetting the Test Tool	48
	Changing the Information Language	48
	Changing the Display	49
	Adjusting the Screen Contrast	49

Setting the Grid Display	49
Changing Date and Time	50
Saving Battery Life	51
Setting the Power Down Timer	51
Changing the Auto Set Options	52
Using Proper Grounding.....	53
Solving Printing and Other Communication Errors	54
4 Specifications	55
Introduction	55
Dual Input Oscilloscope.....	56
Vertical.....	56
Horizontal	57
Trigger	57
Advanced Scope Functions	58
Dual Input Meter.....	59
Input A and Input B.....	59
Input A	60
Advanced Meter Functions.....	61
Miscellaneous.....	62
Environmental	63
Safety	64

Declaration of Conformity

for
Fluke 123
ScopeMeter® test tool

Manufacturer

Fluke Industrial B.V.
Lelyweg 1
7602 EA Almelo
The Netherlands

Statement of Conformity

Based on test results using appropriate standards,
the product is in conformity with
Electromagnetic Compatibility Directive 89/336/EEC
Low Voltage Directive 73/23/EEC

Sample tests

Standards used:

EN 61010.1 (1993)
Safety Requirements for Electrical Equipment for
Measurement, Control, and Laboratory Use

EN 50081-1 (1992)
Electromagnetic Compatibility.
Generic Emission Standard:
EN55022 and EN60555-2

EN 50082-2 (1992)
Electromagnetic Compatibility.
Generic Immunity Standard:
IEC1000-4 -2, -3, -4, -5

The tests have been performed in a
typical configuration.

This Conformity is indicated by the symbol ,
i.e. "Conformité européenne".

Unpacking the Test Tool Kit

Note

The following items are included in your test tool kit. (see Figure 1.):

When new, the rechargeable Ni-Cd battery pack is not fully charged. See Chapter 2.

#	Description	Model	
		123	123/SCC
1	Industrial ScopeMeter Test Tool	●	●
2	Ni-Cd Battery Pack (installed)	●	●
3	Power Adapter/Battery Charger	●	●
4	Shielded Test Leads (red and gray) with black ground leads	●	●
5	Test Lead (black)	●	●
6	Hook Clips (red and gray)	●	●
7	Alligator Clips (red, gray, and black)	●	●
8	Banana-to-BNC Adapter(s) (Black)	● (1x)	● (2x)
9	Fluke 123 Users Manual (this book)	●	●
10	Product Registration Card with Envelope	●	●
11	Shipment box	●	
12	Optically Isolated RS-232 Adapter/Cable		●
13	FlukeView [®] ScopeMeter [®] Software for Windows [®]		●
14	Hard Carrying Case		●

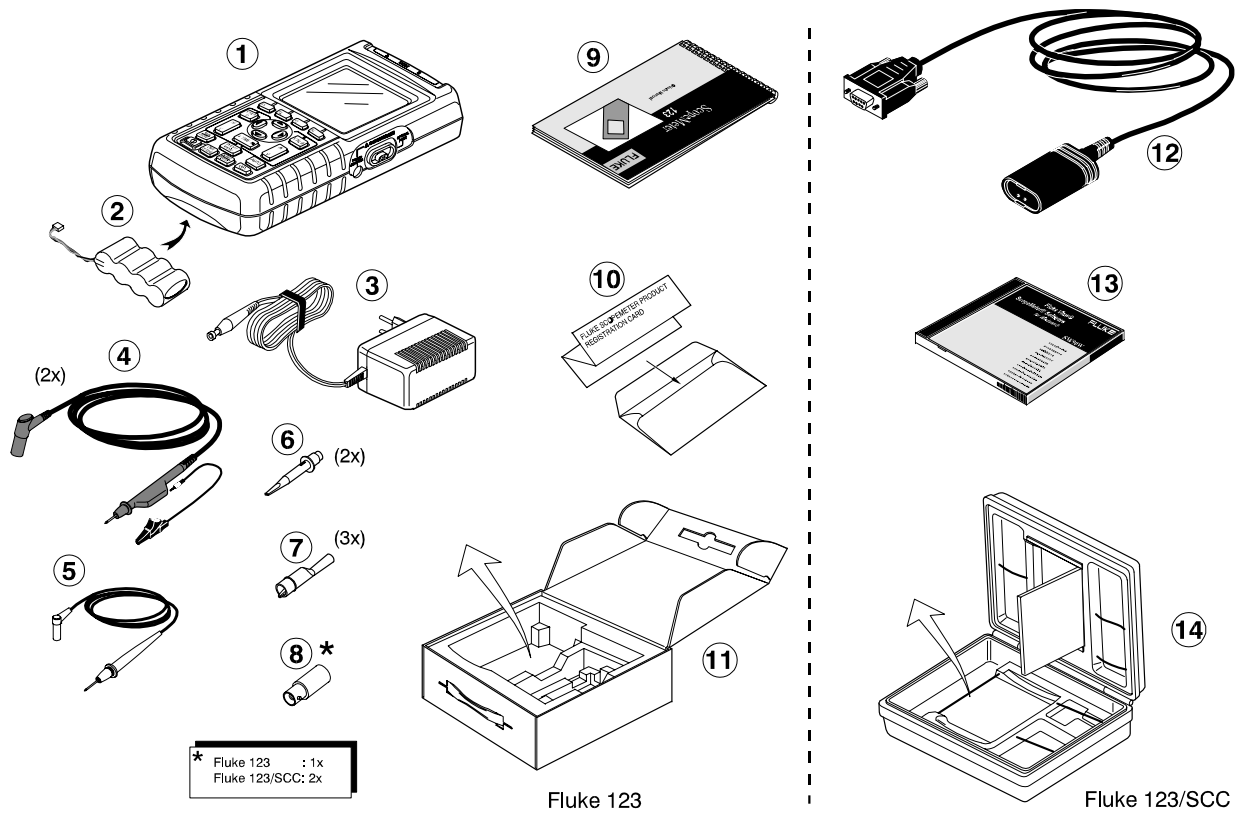

* Fluke 123 : 1x
 Fluke 123/SCC: 2x

Safely Using the Test Tool

Attention

Carefully read the following safety information before using the test tool.

Safety Precautions

Specific warning and caution statements, where they apply, will be found throughout the manual.









A Caution identifies conditions and actions that may damage the test tool.

A Warning identifies conditions and actions that pose hazard(s) to the user.

Symbols used on the test tool and in this manual are explained in the next table.

Warning

To avoid electrical shock, use only Fluke power supply, Model PM8907 (Power Adapter/Battery Charger).

	See explanation in manual		Equal potential inputs
	Disposal information		Earth
	Recycling information		Conformité Européenne
	Double Insulation (Protection Class)		UL 3111 listed
			UL 1244 listed

Warning

Should this test tool be used with AC coupling selected, or manual operation of amplitude or time base ranges, the measuring results displayed on the screen may not be representative of the total signal. This can result in the presence of dangerous voltages of more than 42V peak (30V rms), not being detected. To guarantee user safety, all signals should first be measured with DC coupling selected and in fully automatic mode. This ensures that the full signal content is measured.

 **Warning** 

Do the following to avoid electrical shock or fire if a test tool common input is connected to more than 42V peak (30V rms):

- **Use only test leads and test lead adapters supplied with the test tool. (or equivalents as specified in the accessory list, see Chapter 2.)**
- **Do not use conventional exposed metal banana plug connectors.**
- **Use only one common connection to the test tool.**
- **Remove all test leads that are not in use.**
- **Use 600V (or more) rated and marked test lead adapters. The maximum allowable input voltage is 600V.**
- **Connect the power adapter to the AC outlet before connecting it to the test tool.**
- **Do not insert metal objects in the power adapter connector.**

The terms 'Isolated' or 'Electrically floating' are used in this manual to indicate a measurement in which the test tool COM (common, also called ground) is connected to a voltage different from earth ground.

The term "Grounded" is used in this manual to indicate a measurement in which the test tool COM (common) is connected to an earth ground potential. For more information about proper grounding, see Chapter 3.

The test tool COM (common) inputs (red INPUT A shield, gray INPUT B shield, and black 4-mm banana jack) are connected internally via self-recovering fault protection. The input connectors have no exposed metal and are fully insulated to protect against electrical shock. The black 4 mm banana jack COM (common) can be connected to a voltage above earth ground for isolated (electrically floating) measurements and is rated up to 600V rms above earth ground.

If Safety-Precautions are Impaired

Use of the test tool in a manner not specified may impair the protection provided by the equipment.

Before use, inspect the test leads for mechanical damage and replace damaged test leads!

Whenever it is likely that safety has been impaired, the test tool must be turned off and disconnected from the line power. The matter should then be referred to qualified personnel. Safety is likely to be impaired if, for example, the test tool fails to perform the intended measurements or shows visible damage.

Chapter 1 Using The Test Tool

Goal of this Chapter

This Chapter provides a step-by-step introduction to the test tool. The introduction does not cover all of the capabilities of the test tool but gives basic examples to show how to use the menus perform basic operations.

Powering the Test Tool

Follow the procedure (step 1 to 3) in Figure 1-1 to power the test tool from a standard ac outlet. See Chapter 2 for battery power instructions.

 Turn the test tool on.

The test tool powers up in its last setup configuration.

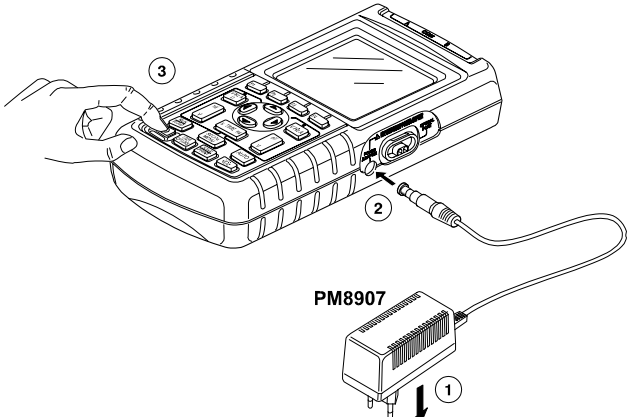





Figure 1-1. Powering the Test Tool

Resetting the Test Tool

If you want to restore the test tool settings as delivered from the factory, do the following:

- ①  Turn the test tool off.
- ②  Press and hold.
- ③  Press and release.

The test tool turns on, and you should hear a double beep, indicating the Reset was successful.

- ④  Release.

Now look at the display; you will see a screen that looks like Figure 1-2.

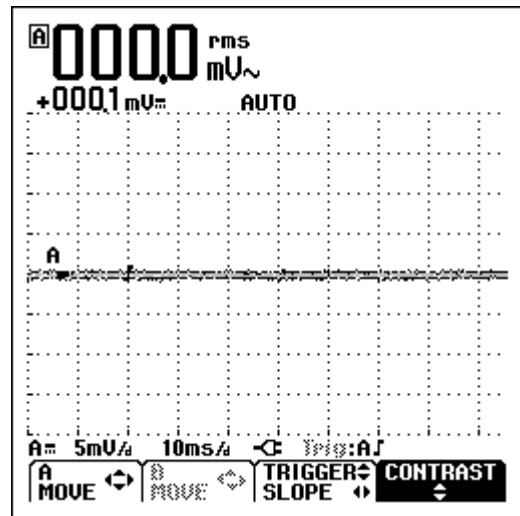



Figure 1-2. The Screen After Reset

Changing Backlight

After power-up, the screen has a high bright display .

To save battery power, the screen has an economic brightness display when operated on the battery pack (no power adapter connected).

To change the brightness of the display , do the following:

- | | | |
|---|--|-------------------------------|
| ① |  | Dim the backlight. |
| ② |  | Brighten the backlight again. |

The high brightness increases when you connect the power adapter.

Note

Using dimmed display lengthens maximum battery power operation time by about one hour.

Reading the Screen

The screen is divided into three areas: Reading area, Waveform area, and Menu area. Refer to Figure 1-3 during the following.

Reading area (A): Displays the numeric readings. Because only input A is on, you will see the input A readings only.

Waveform area (B): Displays the input A waveform. The bottom line displays the ranges/div and the power indicator (line or battery). Because only input A is on, you will see the input A waveform only.

Note

When battery powered, the battery indicator informs you about the condition of the battery from full to empty: .

Menu area (C): Displays the menu that provides choices available through the blue function keys.

When you change a setup, a part of the screen is used to display the choices. The area displays one or more menus with choices accessed with the arrow keys:

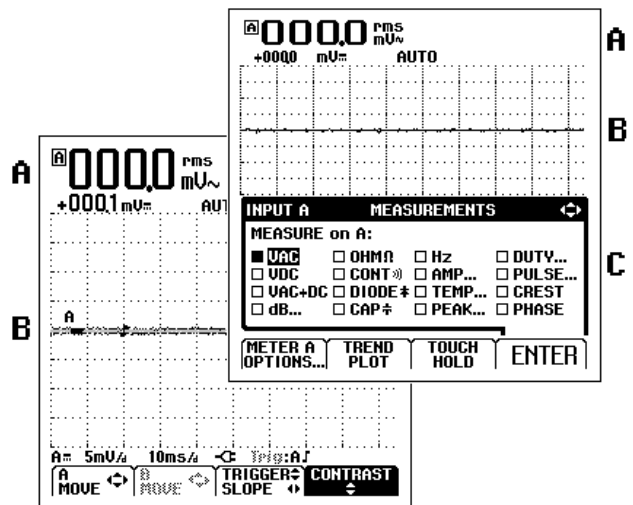
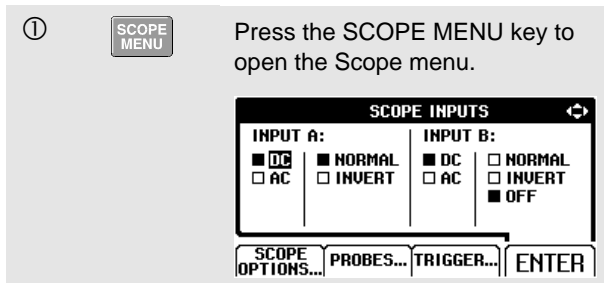

Figure 1-3. The Screen Area's

Making Selections in a Menu

Subsequently follow steps ① to ④ to open a menu and to choose an item.



Note

Pressing the SCOPE MENU key a second time closes this menu and resumes normal measurement. This toggling enables you to check the menu without destroying your settings.

- ② Use the blue arrow keys to highlight the item.
- ③ Press the blue 'ENTER' function key to confirm selection
- ④ Press 'ENTER' until you return to normal mode.

Figure 1-4 shows the basic navigation of the test tool.

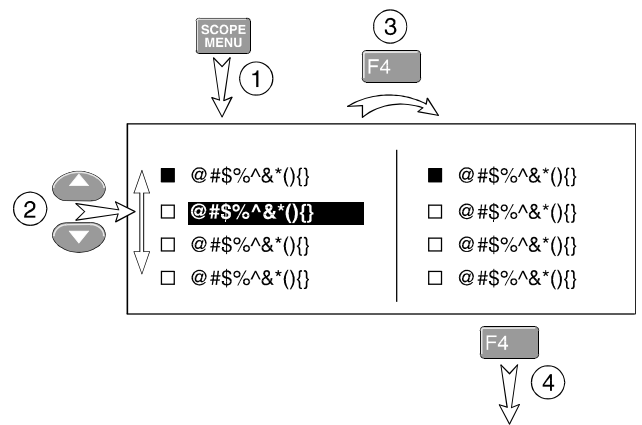

Figure 1-4. Basic Navigation

Note

When you do not change an item with the blue arrow keys, repeatedly pressing enables you to step through a menu without changing the setup of the test tool.

Looking at the Measurement Connections

Look at the top of the test tool. The test tool provides two 4-mm safety shielded banana jack inputs (red input A and gray input B) and a safety 4-mm banana jack input (COM). (See Figure 1-5.)

Input A

You can always use the red input A for all single input measurements possible with the test tool.



Input B

For measurements on two different signals you can use the gray input B together with the red input A.

COM

You can use the black COMmon as single ground for low frequency measurements, and for Continuity, Ohm (Ω), Diode, and Capacitance measurements.

Warning

To avoid electrical shock or fire, use only one COM  (common) connection, or ensure that all connections to COM  are at the same potential.

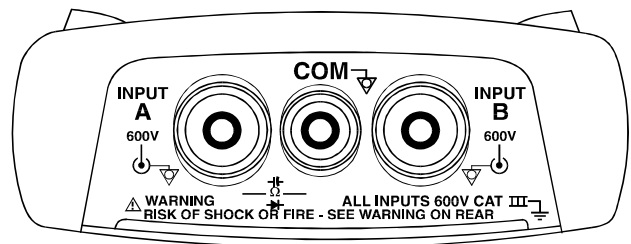

Figure 1-5. Measurement Connections

Displaying an Unknown Signal with Connect-and-View™

The Connect-and-View™ function enables hands-off operation to display complex unknown signals. This function optimizes the position, range, time base, and triggering and assures a stable display on nearly all waveforms. If the signal changes, the setup will track these changes.

To enable the Connect-and-View™ function, do the following:

- Connect the red test lead from red input A to the unknown signal to be measured .

AUTO

Perform an Auto Set.

In the next example, the screen displays “1.411” in large numbers and “-0.103” in smaller numbers. A scope trace gives a graphical representation of the waveform.

The trace identifier (**A**) is visible on left of the waveform area. The zero icon (■) identifies the ground level of the waveform.

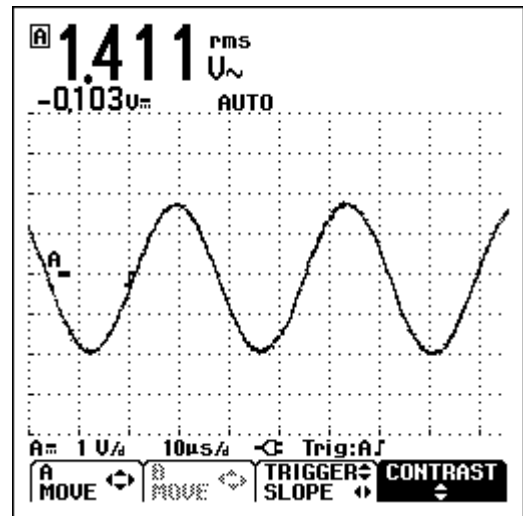

Figure 1-6. The Screen After an Auto Set

Making Measurements

The reading area displays the numeric readings of the chosen measurements on the waveform that is applied to the input jack.

- First connect the red shielded test lead from input A, and the gray shielded test lead from input B to the signals to be measured. Connect the short ground leads to the same ground potential. (See Figure 1-7.)

Note

For Ohm (Ω), continuity, diode, and capacitance measurements, use the red shielded test lead from input A and the black unshielded ground lead from COM (common). (See Figure 1-7.)

To choose a frequency measurement for Input A, do the following:

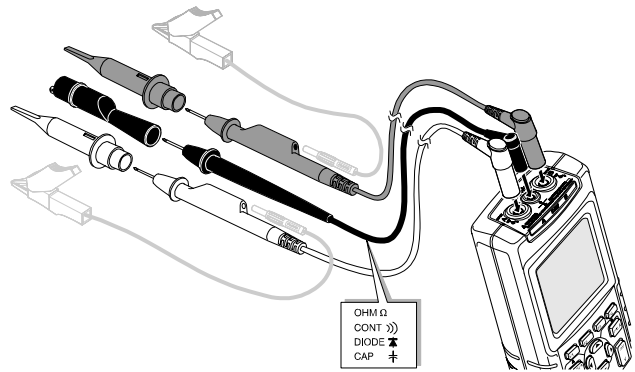
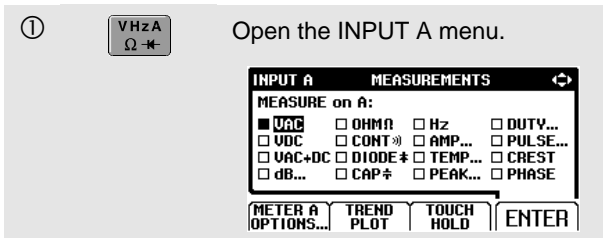
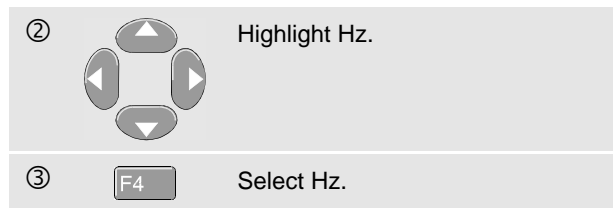



Figure 1-7. Measurement Setup





Observe that Hz is now the main reading. The former main reading has now moved to the smaller secondary reading position. (See Figure 1-8.)

To choose also a Peak-to-Peak measurement for Input B, do the following:

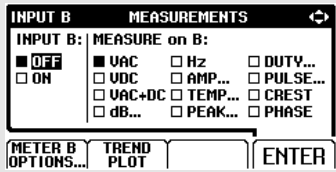
①  Open the INPUT B menu.



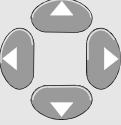

②  Highlight ON.

③  Turn Input B on. Observe that the highlight jumps to the present main measurement.

④  Highlight PEAK...

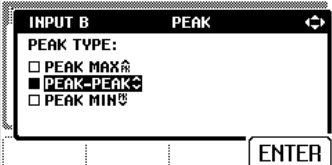
⑤  Open the PEAK submenu.



⑥  Highlight PEAK-PEAK.

⑦  Accept the pk-pk measurement.

Now, you will see a screen like Figure 1-8.

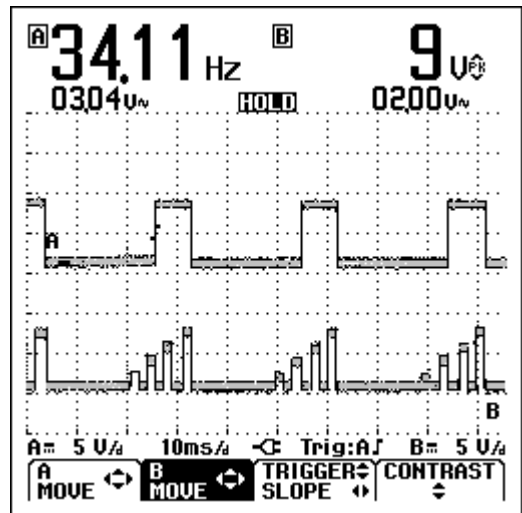



Figure 1-8. Hz and Vpp as Main Readings

Freezing the Screen



You can freeze the screen (all readings and waveforms) at any time.

- | | | |
|---|---|---|
| ① |  | Freeze the screen. HOLD appears at the bottom of the reading area. |
| ② |  | Resume your measurement. |

Holding a Stable Reading

The Touch Hold[®] function captures and freezes the next stable measurement result. A beep indicates that a stable measurement has been made.

Use the following procedure for the Touch Hold function:

- | | | |
|---|---|---|
| ① |  | Open the INPUT A menu. |
| ② |  | TOUCH HOLD OFF appears on bottom of the screen. |
| ③ | | Measure the signal. |
| ④ | BEEP))) | Wait until an audible beep: now you have a stable display.



The screen continues to update with valid readings (and beeps) as long as you maintain the measurement connections. |



Because no special keys accompany the Touch Hold function, you can use this function for hands-free measurements.

- | | | |
|---|---|-------------------------------|
| ⑤ |  | Return to normal measurement. |
|---|---|-------------------------------|

Making Relative Measurements

Zero Reference displays the present measurement result with respect to the defined value. This feature is useful when you need to monitor the measured value in relation to a known good value.

- ①  Open the INPUT A menu.
- ②  Open the METER A OPTIONS submenu.

INPUT A	METER OPTIONS	
COUPLING:	SMOOTHING:	ZERO REF:
<input checked="" type="checkbox"/> AC+DC	<input type="checkbox"/> FAST	<input checked="" type="checkbox"/> OFF
<input type="checkbox"/> AC ONLY	<input checked="" type="checkbox"/> NORMAL	<input type="checkbox"/> ON
	<input type="checkbox"/> SMOOTH	
BACK...	TREND PLOT	TOUCH HOLD
		ENTER
- ③  (2x) Jump to ZERO REF.
- ④  Highlight ON.
- ⑤  Activate the relative measurement.

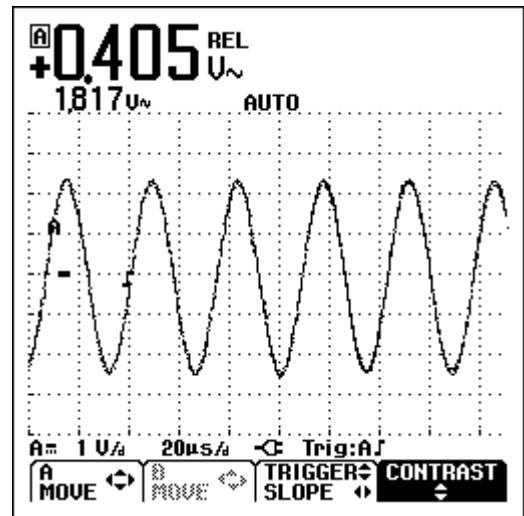



Figure 1-9. Making a Relative Measurement

The relative measurement now becomes the main reading, while the former main measurement has moved to the smaller secondary reading position. (See Figure 1-9.)

Selecting Auto/Manual Ranges



Press  to automatically adjust the position, range, time base, and triggering. This assures a stable display on nearly all waveforms. The bottom line shows the range, the time base for both inputs, and the trigger information.

Press  a second time to select the manual range. **MANUAL** appears at the bottom of the reading area.

Changing the Graphic Representation on the Screen

From Auto range, you can use the light-gray rocker keys to change the graphic representation on the screen manually.



Changing the Amplitude

①		Enlarge the waveform.
②		Reduce the waveform.

Available settings are from 5 mV/div to 500 V/div when using the test leads.

Observe that **AUTO** at the bottom of the reading area disappears to indicate that the continuous Auto Set function is not valid anymore.

Changing the Time Base

①		Increase the number of periods.
②		Decrease the number of periods.

Available settings are from 20 ns/div to 5 s/div in normal mode.

Positioning the Waveform on the Screen

Considerable flexibility is offered in moving the waveform(s) around the screen.

- ①  Press until you have left any open menu. Observe that the following main menu appears on bottom of the screen.

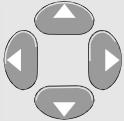
A MOVE	B MOVE	TRIGGER SLOPE	CONTRAST
--------	--------	---------------	----------
- ②  Choose A MOVE.
- ③  Position the waveform of INPUT A on the screen.

Waveform positioning is demonstrated in Figure 1-10.

Observe that the trigger identifier (\lrcorner) moves horizontally on the screen.

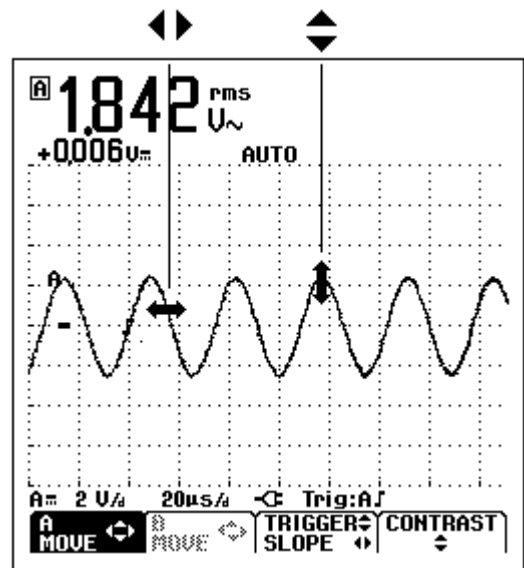

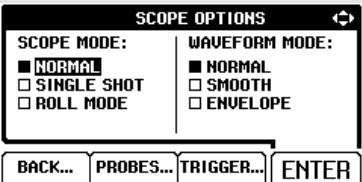





Figure 1-10. Positioning the Waveform

Smoothing the Waveform

To smooth the waveform, do the following:

- ①  Open the SCOPE INPUTS menu.
- ②  Open the SCOPE OPTIONS submenu.

- ③  Jump to WAVEFORM MODE.
- ④  Highlight SMOOTH.
- ⑤  Accept waveform smooth.

You can use waveform smooth to suppress noise without loss of bandwidth. Waveform samples with and without smoothing are shown in Figure 1-11.

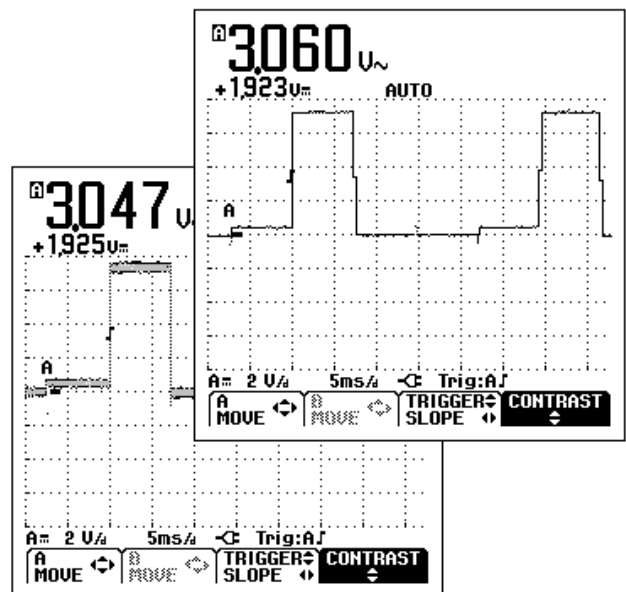



Figure 1-11. Smoothing the Waveform

Displaying the Envelope of a Waveform

The test tool records the envelope (minimum and maximum) of the live waveforms A and B.

Repeat the first three actions of 'Smoothing the Waveform', and then do the following:

- | | | |
|---|---|--|
| ④ |  | Highlight ENVELOPE. |
| ⑤ |  | Start monitoring the envelope of the waveform. |

The screen shows the resultant envelope in a gray waveform. See Figure 1-12.

You can use ENVELOPE to observe variations in time or amplitude of input waveforms over a longer period of time.

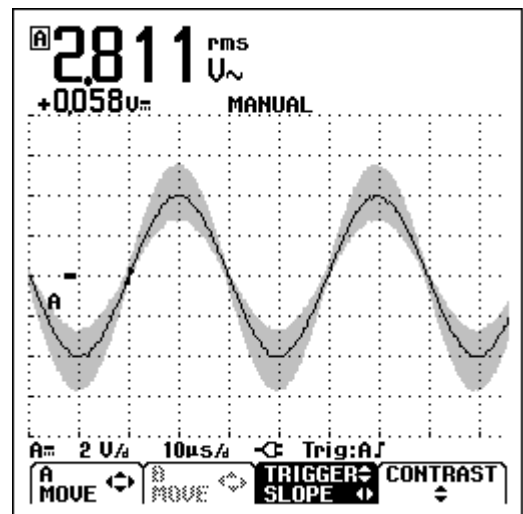



Figure 1-12. Displaying the Envelope of a Waveform

TrendPlotting a Waveform

The TrendPlot™ function plots the digital readings as a function of time. Date and time stamp shows the time of the most recent change in a MIN or MAX reading.

Starting a TrendPlot™ function

- ①  Open the INPUT A menu.
- ②  Start TRENDPLOT.

The test tool records the minimum (MIN) reading as the main (upper displayed) measurement of input A. The date and time stamp appear below the MIN reading. (See Figure 1-13.)

The test tool also continuously logs all readings to memory and displays these as graphs. Automatic vertical scaling and horizontal time compression resizes the TrendPlot to fit on the screen. The TrendPlot is built up on the screen from left to right until the screen is full. The automatic time scaling then compresses this information to about half the screen.

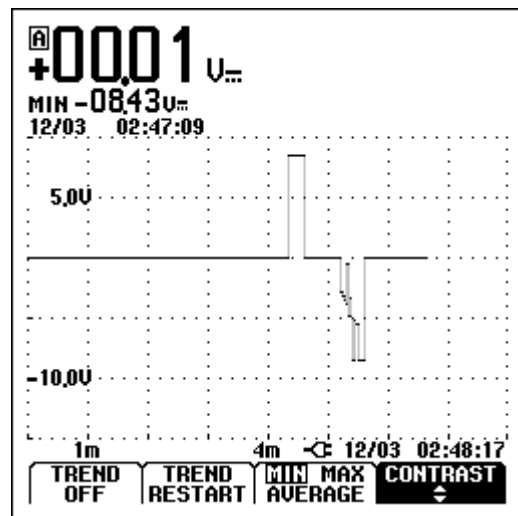

Figure 1-13. TrendPlot Reading

Note

When a new minimum value is detected, a beep occurs and the new minimum is displayed.

Changing the TrendPlot Reading

To toggle the TrendPlot reading between MIN (minimum), MAX (maximum), and AVERAGE, do the following:

- ③  Change MIN into MAX reading.
- ④  Change MAX into AVG reading.

Note that the date and time stamp now updates continuously to indicate the most recent change in a reading.

Turning Off the TrendPlot Display



- ⑤  Turn TrendPlot off again.

Acquiring the Waveform

Making a Single Acquisition



To catch single events, you can perform a single shot. (One time screen update.) To set up the test tool for a single shot on the input A waveform, do the following:

- Connect the probe to the signal to be measured.

- ①  Open the SCOPE INPUTS menu.
- ②  Open the SCOPE OPTIONS submenu.

SCOPE OPTIONS ↔

SCOPE MODE: <input checked="" type="checkbox"/> NORMAL <input type="checkbox"/> SINGLE SHOT <input type="checkbox"/> ROLL MODE	WAVEFORM MODE: <input checked="" type="checkbox"/> NORMAL <input type="checkbox"/> SMOOTH <input type="checkbox"/> ENVELOPE
---	--

BACK...
PROBES...
TRIGGER...
ENTER
- ③  Highlight SINGLE SHOT.
- ④  (2x) Accept the set up for a Single Shot.

- ⑤ HOLD
RUN **Wait** appears on bottom of the screen to indicate that the test tool is waiting for a trigger.
- ⑥ **Run** appears on bottom of the screen when the single acquisition is triggered.
- ⑦ **Hold** appears on bottom of the screen when the single acquisition has been completed.

The test tool will now have a screen like Figure 1-14.

To perform a next single acquisition, do the following:

- HOLD
RUN Wait for another single acquisition trigger.

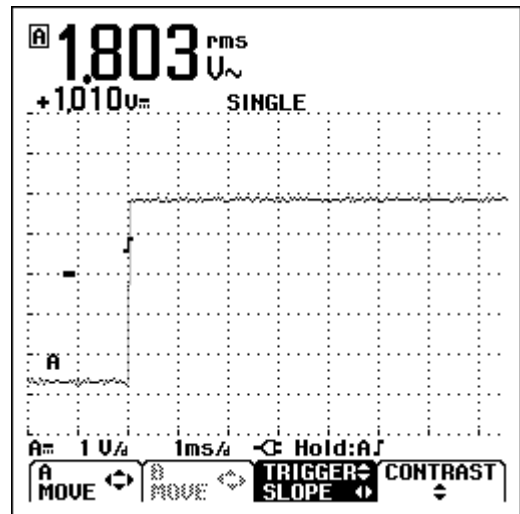

Figure 1-14. Making a Single Acquisition

Recording Slow Signals over a Long Period of Time

The roll mode function supplies a visual log of waveform activity and is especially useful when you measure lower frequency waveforms.

①		Open the SCOPE INPUTS menu.
②		Open the SCOPE OPTIONS submenu.
③		Highlight ROLL MODE.
④		Start Recording.

The waveform moves across the screen from right to left like a normal chart recorder. Observe that during recording no measurements are made. (See Figure 1-15.)

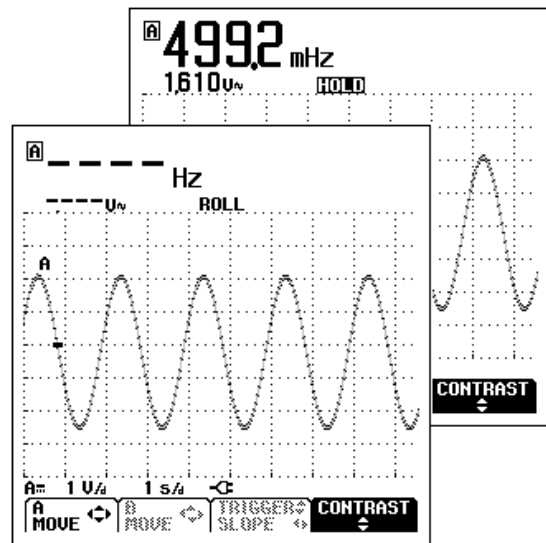



Figure 1-15. Recording Waveforms over Longer Period of Time

⑤		Freeze Recording.
---	--	-------------------



Observe that the measurement values are only displayed after is pressed. (See figure 1-15.)

Selecting AC-Coupling

Use AC-coupling when you wish to observe a small AC signal that rides on a DC signal.

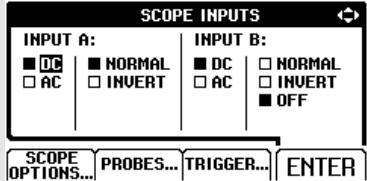
①  Open the SCOPE INPUTS menu.



②   Highlight AC.

③  (4x) Accept AC-coupling for INPUT A.



Reversing the Polarity of the Displayed Waveform

To invert the input A waveform, do the following:

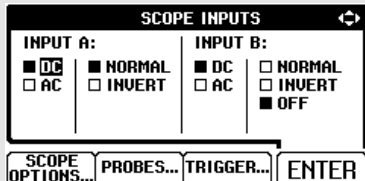
①  Open the SCOPE INPUTS menu.



②  Select NORMAL (of INPUT A).

③   Highlight INVERT.

④  (3x) Accept inverted waveform display.

For example, a negative-going waveform is displayed as positive-going, providing a more meaningful viewing perspective in some cases. An inverted display is identified by trace identifier **A** on left of the waveform area.

Triggering on a Waveform

Triggering tells the test tool when to begin displaying the waveform. You can select which input signal should be used, on which edge this should occur, and you can define the condition for a new update of the waveform. Finally you can tell the test tool to trigger on video signals.





The bottom line of the waveform area identifies the trigger parameters being used. Trigger icons on the screen indicate the trigger level and slope. (See Figure 1-16.)



Setting Trigger Level and Slope

- ①  Perform an AUTO SET.

For quick operation, use the AUTO SET key to automatically trigger on nearly all signals. To optimize trigger level and slope manually, do the following:

- ①  Press until you have left any open menu.

   
- ②  Enable the arrow keys for Trigger Level and Slope adjustment.

- ③  Adjust the Trigger Level continuously. Observe the trigger icon on the second time division line indicates the trigger level.
- ④  Trigger on either positive Slope or negative Slope of the chosen waveform.

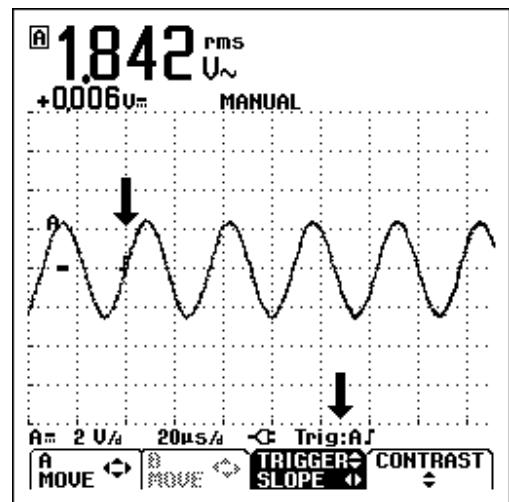

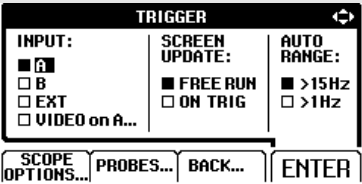







Figure 1-16. Screen with all Trigger Information

Selecting the Trigger Parameters

To trigger on the input A waveform, with automatic screen update, and to configure the auto range triggering for waveforms from 1 Hz, do the following:

①		Open the SCOPE INPUTS menu.
②		Open the TRIGGER submenu.
		
③		Highlight Input 'A'.
④		Select Input 'A'.
⑤		Highlight FREE RUN.
⑥		Select FREE RUN.
⑦		Highlight >1 Hz

⑧		Accept all trigger selections and return to normal measurement.
---	---	---

Note

Setting the automatic triggering to >1Hz will slow down the auto range.

TRIG:A appears in gray text on bottom of the screen when no trigger is found.

Note

Gray text in a menu or button bar indicates that the function is disabled or the status is not valid.

Isolated Triggering

Use the optically isolated trigger probe (ITP120, optional) to trigger on an external source, and to isolate the test tool from a trigger waveform. See Figure 1-17.

To choose the isolated trigger probe, select 'EXT' in point ④ of the previous example. Trigger level is fixed and is TTL compatible.

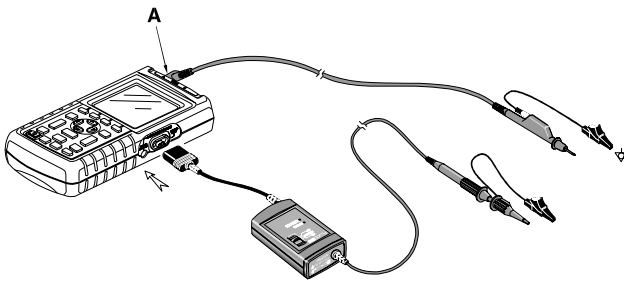

Figure 1-17. Isolated Triggering



Triggering on Video Signals

- Apply an interlaced video signal to the red input A.

To trigger on a random video line, continue from point ② of the previous example as follows:

③		Highlight VIDEO on A.																					
④		Open the VIDEO TRIGGER submenu.																					
<table border="1"> <thead> <tr> <th colspan="3">VIDEO TRIGGER</th> </tr> </thead> <tbody> <tr> <td>SYSTEM:</td> <td>LINE:</td> <td>POLARITY</td> </tr> <tr> <td><input checked="" type="checkbox"/> PAL</td> <td><input type="checkbox"/> RANDOM</td> <td><input checked="" type="checkbox"/> POSITIVE</td> </tr> <tr> <td><input type="checkbox"/> NTSC</td> <td><input checked="" type="checkbox"/> SELECT</td> <td><input type="checkbox"/> NEGATIVE</td> </tr> <tr> <td><input type="checkbox"/> PALplus</td> <td></td> <td></td> </tr> <tr> <td><input type="checkbox"/> SECAM</td> <td></td> <td></td> </tr> <tr> <td colspan="2"></td> <td style="text-align: right;"></td> </tr> </tbody> </table>			VIDEO TRIGGER			SYSTEM:	LINE:	POLARITY	<input checked="" type="checkbox"/> PAL	<input type="checkbox"/> RANDOM	<input checked="" type="checkbox"/> POSITIVE	<input type="checkbox"/> NTSC	<input checked="" type="checkbox"/> SELECT	<input type="checkbox"/> NEGATIVE	<input type="checkbox"/> PALplus			<input type="checkbox"/> SECAM					
VIDEO TRIGGER																							
SYSTEM:	LINE:	POLARITY																					
<input checked="" type="checkbox"/> PAL	<input type="checkbox"/> RANDOM	<input checked="" type="checkbox"/> POSITIVE																					
<input type="checkbox"/> NTSC	<input checked="" type="checkbox"/> SELECT	<input type="checkbox"/> NEGATIVE																					
<input type="checkbox"/> PALplus																							
<input type="checkbox"/> SECAM																							
⑤		Highlight PAL.																					
⑥		Select PAL.																					
⑦		Highlight RANDOM.																					
⑧		Select RANDOM.																					

Fluke 123
Users Manual

- ⑨  Highlight POSITIVE.
- ⑩  Accept the video trigger selections .

Trigger level and slope are now fixed. (See Figure 1-18.) Positive video is indicated as a “+” icon on bottom of the screen.

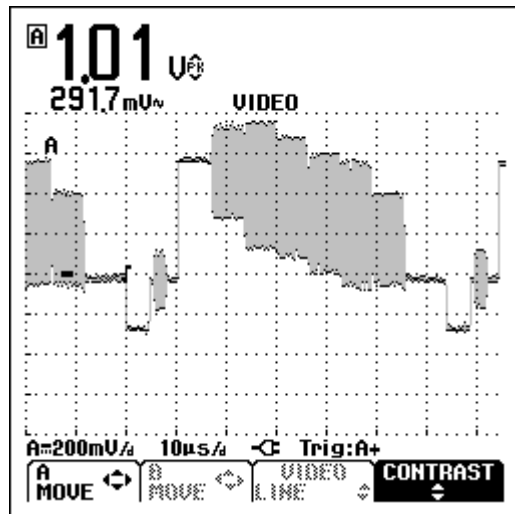





Figure 1-18. Measuring Video Signals

Triggering on a Specific Video Line



To view a specific video line in more detail you can select the line number. To measure on a selected video line, continue from point ⑥ of the previous example as follows:

⑦   Highlight SELECT

VIDEO TRIGGER  

SYSTEM:	LINE:	POLARITY
<input checked="" type="checkbox"/> PAL	<input type="checkbox"/> RANDOM	<input checked="" type="checkbox"/> POSITIVE
<input type="checkbox"/> NTSC	<input checked="" type="checkbox"/> SELECT	<input type="checkbox"/> NEGATIVE
<input type="checkbox"/> PALplus		
<input type="checkbox"/> SECAM		



⑧  Select SELECT

⑨   Highlight POSITIVE.

⑩  Accept the video trigger selections .

Pressing  selects the line number function.

To choose line 135, do the following:

- ①  Enable video line selection.
- ②   Select number 135.

Saving and Recalling a Setup or a Screen

You can save Screens and Setups to memory, and recall them again from memory. Two Screen memories and ten Setup memories are available. Save Screens when you want to use the present screen image for future reference. Save a Setup when you need the present operating configuration more often for your measurements.

Note

Because the navigations for Setups and Screens are identical, only saving and recalling Screens are explained in this Section.

Saving Screens

To save a screen, do the following:

①  Open the SAVE&PRINT menu.

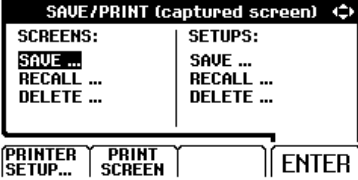

Observe that SCREENS SAVE is already highlighted.



Note

From this point the screen is frozen until you leave the SAVE&PRINT menu again.

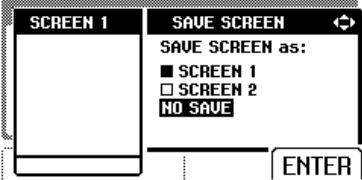
②  Open the SAVE SCREEN submenu.



Note that free memory locations are indicated by an open square () before the memory number.



③   Highlight SCREEN 2.

④  Save the actual screen.

Recalling Screens

To recall a screen, do the following:

①  Open the SAVE&PRINT menu.

②   Highlight SCREENS RECALL.

③  Open the RECALL SCREEN submenu.

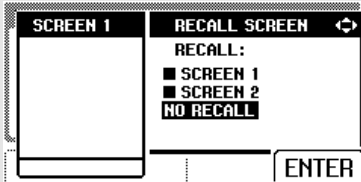

Already filled memory locations are indicated with a closed square (■).

④  Highlight SCREEN 2.

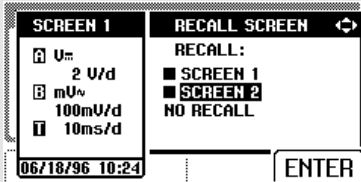



⑤  View the saved screen.

The image is presented as a picture that can no longer be changed.

Deleting Screens

To delete all screen memories, do the following:

①  Open the SAVE&PRINT menu.

②  Highlight SCREENS DELETE.

③  Open the DELETE SCREEN submenu.

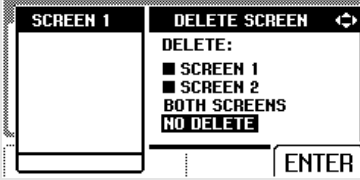

Filled memory locations are indicated with a closed square.

④  Highlight BOTH SCREENS.

⑤  Delete all screen memories.

Using a Printer

To print a (graphic) hard copy of the present screen, you need to use one of the following:

- The Optically Isolated RS-232 Adapter/Cable (PM9080) to connect a serial printer to the OPTICAL PORT of the test tool. See Figure 1-19.
- The Print Adapter Cable (PAC91, optional) to connect a parallel printer to the OPTICAL PORT of the test tool. See Figure 1-20.

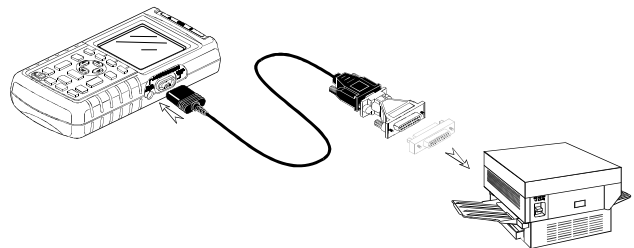

Figure 1-19. Connecting a Serial Printer

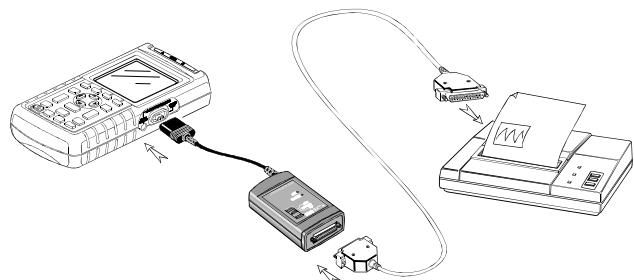

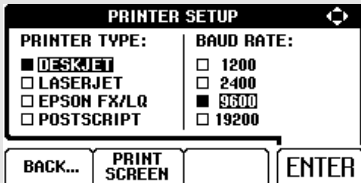







Figure 1-20. Connecting a Parallel Printer

This example covers how to set up the test tool to print on a HP Deskjet printer with a baudrate of 9600 baud:

①		Open the SAVE&PRINT menu. Observe that the screen is frozen.
②		Open the PRINTER SETUP submenu.
		
③		Highlight DESKJET.
④		Select DESKJET.
⑤		Highlight 9600.
⑥		Accept the print selections.

Now you are ready to print.

To print a **live** screen, do the following:

⑦		Open the SAVE&PRINT menu.
⑧		Start printing.

To print a **recalled** screen, do the following:

⑦		Start printing.
---	--	-----------------

A message that indicates that the test tool is printing appears on bottom of the screen.

Using FlukeView[®] Software

To connect the test tool to a computer for using the FlukeView software for Windows[®] (SW90W), do the following:

- Use the Optically Isolated RS-232 Adapter/Cable (PM9080) to connect a computer to the OPTICAL PORT of the test tool. See Figure 1-21.

For all information relating to installing and using the FlukeView ScopeMeter software, see the SW90W Users Manual.

A Software & Cable Carrying Case Kit is optional available as model number SCC 120.

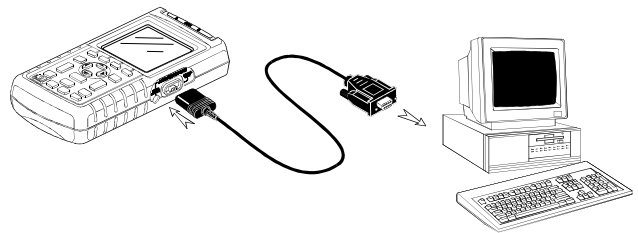

Figure 1-21. Connecting a Computer

Chapter 2

Maintaining the Test Tool

About this Chapter

This chapter covers basic maintenance procedures that can be performed by the user. For complete service, disassembly, repair, and calibration information, see the Service Manual. You will find the part number of the Service Manual in the section 'Parts and Accessories' in this manual.

Cleaning the Test Tool



Clean the test tool with a damp cloth and a mild soap to avoid abrasion of text on the test tool. Do not use abrasives, solvents, or alcohol.

Storing the Test Tool

If you are storing the test tool for an extended period of time, charge the Ni-Cd battery pack before storing. It is not necessary to remove the battery pack.

Charging the Ni-Cd Battery Pack

At delivery, the Ni-Cd batteries may be empty and must be charged for 4 hours (test tool is off) to fill them completely. When fully charged, the batteries typically provide 4 hours of use at full brightness and 5 hours at normal brightness.

When battery powered, the battery indicator on the bottom of the screen informs you about the condition of the battery. The battery symbols are: . The battery symbol  indicates that there are typically five minutes of operating time left.

Use the setup as shown in Figure 2-1 to charge the battery pack and power the instrument.

Turn the test tool off to charge the batteries more quickly.

Note

The test tool uses a trickle charge for the batteries, so no damage can occur if you leave it charging for long periods, e.g., through the weekend.

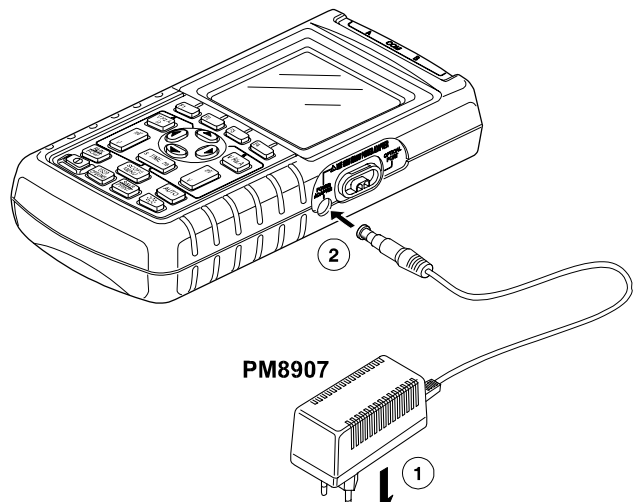



Figure 2-1. Charging the Battery Pack

Keeping Batteries in Optimal Condition

Always operate the test tool on batteries until an -icon appears on the bottom line of the screen. This indicates that the battery level is low and that the Ni-Cd batteries need to be recharged.

Frequent charging of the batteries when they are not completely empty can reduce the operating time for the test tool.





You can refresh the battery pack at any time. This battery refresh cycle fully discharges and charges the battery pack. A complete refresh cycle takes about 12 hours and should be done at least four times a year.

Note

Be sure not to disconnect the Power Adapter during the complete refresh cycle. Doing so will interrupt the refresh cycle.

To refresh the battery pack, do the following:

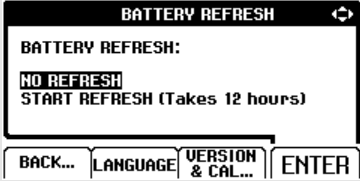
- Be sure that the test tool is line powered.

①		Open the USER OPTIONS menu.
②		Open the BATTERY REFRESH submenu.
		
③		Highlight START REFRESH.
④		Start the refresh cycle.

Note

After start of the refresh cycle, the screen will be black. The backlight is on during discharging within the refresh cycle.

Replacing and Disposing of the Ni-Cd Battery Pack

Warning

To avoid electrical shock, remove the test leads and probes before replacing the battery pack.



This instrument contains Nickel-Cadmium batteries. Do not dispose of this battery pack with other solid waste. Used batteries should be disposed of by a qualified recycler or hazardous materials handler. Contact your authorized FLUKE Service Center for recycling information.

To replace the battery pack, do the following: (See Figure 2-2.)

1. Disconnect the test leads and probes both at the source and at the test tool.
2. Power the test tool with the Power Adapter. This ensures information stored in memories will not be lost.
3. Locate the battery access cover on the bottom rear. Loosen the screw with a flat-blade screwdriver.

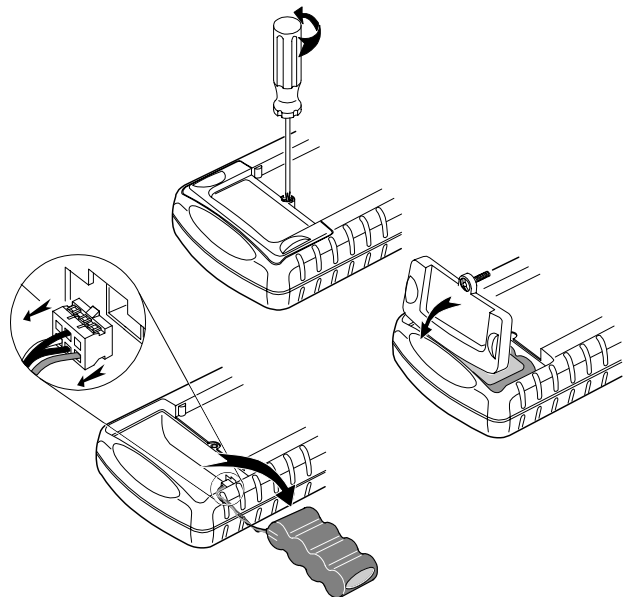

Figure 2-2. Replacing the Battery Pack

4. Lift the battery access cover away from the test tool.
5. Take the battery pack out of the battery compartment.
6. Remove the battery plug from the connector.

7. Install a new battery pack.

Note

Ensure that the battery pack is placed in the battery compartment as shown in Figure 2-2. Use only the Fluke BP120 Ni-Cd battery pack.

8. Reinstall the battery cover and secure the screw.

Using and Adjusting 10:1 Scope Probes

You need to adjust the red and gray scope probes (PM8918, optional) for optimal response.

Warning

To avoid electrical shock use the BB120 Banana-to-BNC adapter (delivered with the test tool) to connect a 10:1 scope probe to the input of the test tool.

To adjust probes, do the following:

- Connect the 10:1 scope probe from the gray input B jack to the red input A jack. Use the red 4-mm banana adapter (delivered with the probe) and the banana-to-BNC adapter (BB120). See Figure 2-3.

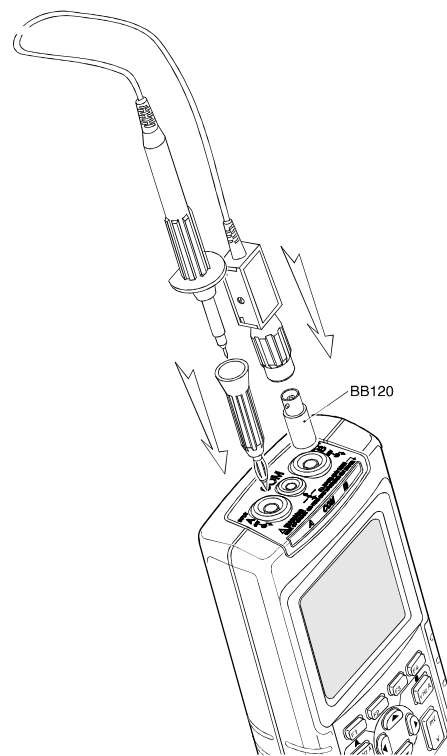







Figure 2-3. Adjusting Scope Probes

①  Open the SCOPE INPUTS menu.

②  Open the PROBES submenu.



③  Highlight PROBE AC ADJUST.

④  Open the PROBE AC ADJUST submenu.

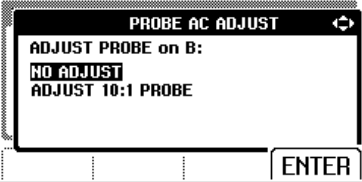

⑤  Highlight ADJUST 10:1 PROBE.

⑥  A square wave appears on the screen.

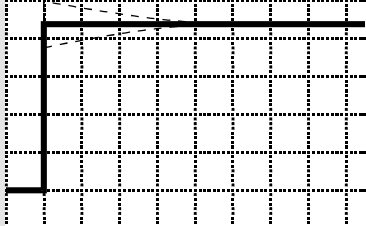

⑦ Adjust the trimmer screw in the probe housing to give an optimum square wave.



⑧  Return to normal mode.

Calibrating the Test Tool

You can ask for the model identity (version and calibration data) at any time. To display the identity, do the following:

①		Open the USER OPTIONS menu.
②		Open the VERSION&CALIBRATION submenu.
		

The screen gives you information about the model number with software version, the calibration number with latest calibration date, and the latest battery refresh date.

③		Return to normal mode.
---	---	------------------------

Recalibration must be carried out by qualified personnel only. Contact your local Fluke representative for recalibration.

Parts and Accessories

Service Manual







Ordering Number: 4822 872 05375

Standard Accessories

The next tables list the user-replaceable parts for the various test tool models. To order replacement parts, contact your nearest service center.

Fluke 123
Users Manual

Standard Accessories (cont)

Item	Ordering Code
Ni-Cd Battery Pack (installed)	BP120
Power Adapter/Battery Charger, available models: Universal Europe 230V, 50Hz North America 120V, 60Hz  United Kingdom 240V, 50Hz Japan 100V, 60Hz Australia 240V, 50Hz Universal 115V/230V *  <i>* The 230V rating of the PM8907/808 is not for use in North America. A line plug adapter complying with the applicable National Requirements may be provided to alter the blade configurations for a specific country.</i>	PM8907/801 PM8907/803 PM8907/804 PM8907/806 PM8907/807 PM8907/808
Set of two Shielded Test Leads (Red and Gray), designed for use only with the Fluke ScopeMeter 120 series test tool.  Set contains the following replaceable part: Ground Lead with Alligator Clip (Black)	STL120 5322 320 11354
Set of two Test Leads (Red and Black)  <small>UL1244</small>	TL75
Set of two Hook Clips (Red and Gray) 	HC120
Set of three Alligator Clips (Red, Gray, and Black)	AC120
Set of two Banana-to-BNC Adapters (Black) 	BB120

Standard Accessories (cont)

Item	Ordering Code
Users Manual (English)	4822 872 00743
Users Manual (German)	4822 872 00744
Users Manual (French)	4822 872 00745
Users Manual (Spanish)	4822 872 00746
Users Manual (Portuguese)	4822 872 00795
Users Manual (Italian)	4822 872 00747
Users Manual (Dutch)	4822 872 00748
Users Manual (Danish)	4822 872 00749
Users Manual (Norwegian)	4822 872 00751
Users Manual (Swedish)	4822 872 00752
Users Manual (Finnish)	4822 872 00753
Users Manual (Chinese)	4822 872 00754
Users Manual (Japanese)	4822 872 00755
Users Manual (Korean)	4822 872 00756

Optional Accessories

Item	Ordering Code
Software & Cable Carrying Case Kit Set contains the following parts: Optically Isolated RS-232 Adapter/Cable Hard Carrying Case Set of two Banana-to-BNC Adapters (Black) FlukeView® ScopeMeter® Software for Windows®	SCC 120 PM9080 C120 BB120 SW90W
Set of 10:1 Scope Probes (Red and Gray)	 PM8918/002 <small>UL1244</small>
Optically Isolated RS-232 Adapter/Cable	PM9080
Hard Carrying Case	C120
Compact Soft Case	C125
Soft Carrying Case	C789
Isolated Trigger Probe	ITP120
Print Adapter Cable for Parallel Printers	PAC91

Chapter 3 Tips and Troubleshooting

Goal of this Chapter

This Chapter gives you information and tips on how you can make the best use of the test tool.

Using the Tilt Stand

The test tool is equipped with a tilt stand, allowing viewing from an angle. You can also use the tilt stand to hang the test tool at a convenient viewing position. Simply tilt the stand and hang the test tool. Typical positions are shown in Figure 3-1.

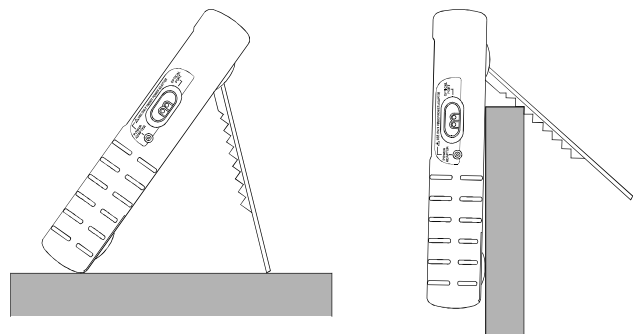





Figure 3-1. Using the Tilt Stand

Resetting the Test Tool

Perform a Master Reset to make sure that your test tool is in the initial settings condition.

- ①  Turn the test tool off.
- ②  Press and hold.
- ③  Press and release.



The test tool turns on, and you should hear a double beep, indicating the Reset was successful.



- ④  Release.

Changing the Information Language

When you operate the test tool, messages appear on the bottom of the screen. These messages are always displayed in a box, and can in some test tool versions be displayed in more languages. In different combinations, you can choose from 10 languages: English, French, German, Italian, Spanish, Portuguese, Dutch, Japanese, Korean, and Chinese.



If you want to change the language of the messages into e.g. Spanish, do the following:

- ①  Open the USER OPTIONS menu.
- ②  Open the LANGUAGE SELECT submenu.

The screenshot shows a menu titled "LANGUAGE" with a right arrow. It lists "ENGLISH" with a selected checkbox and "ESPAÑOL" with an unselected checkbox. At the bottom of the screen, there are four buttons: "BATTERY REFRESH...", "BACK...", "VERSION & CAL...", and "ENTER".
- ③  Highlight ESPAÑOL.
- ④  Accept ESPAÑOL (Spanish) as language.

Changing the Display

Adjusting the Screen Contrast

①   From the main menu, choose CONTRAST.

②  Adjust the contrast of the screen.

Note

The new contrast adjustment of the screen is saved in memory until a new adjustment is made.

Setting the Grid Display

To choose a dotted grid, do the following:

①  Open the USER OPTIONS menu.

②  Highlight GRID TYPE.

③  Open the GRID TYPE submenu.

④  Choose DOTS.

⑤  Accept the new grid display.

Use LINES when you need a cross hatch pattern based on the horizontal time and vertical divisions on the screen. Use DOTS when you need vertical and horizontal division dots as added reference points to the screen.

Changing Date and Time

The test tool has a date and time clock. To change the date to (e.g.) 19 April, 1996, do the following:

①  Open USER OPTIONS menu.



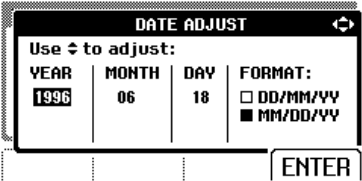

②  Highlight DATE ADJUST.

③  Open DATE ADJUST submenu.





④  Choose 1996.

⑤  Jump to MONTH.

⑥  Choose 04.

⑦  Jump to DAY.

⑧  Choose 19.

⑨  Jump to FORMAT.

⑩  Choose DD/MM/YY.

⑪  Accept the new date.

You can change the time in a similar way by opening the TIME ADJUST submenu. (steps ② and ③.)

Saving Battery Life

When operated on the battery pack (no Power Adapter connected), the test tool conserves power by shutting itself down. If you have not pressed a key for at least 30 minutes, the test tool turns itself off automatically.



Note



If the Power Adapter is connected, there is no automatic power shutdown.

Although automatic power shutdown will not occur if TrendPlot is on, the backlight will dim. Recording will continue even if the battery pack is low, and retention of memories is not jeopardized.

Setting the Power Down Timer

To extend battery life, the power shutdown time is set to 30 minutes after the last key press. To set the power shutdown to five minutes, do the following:

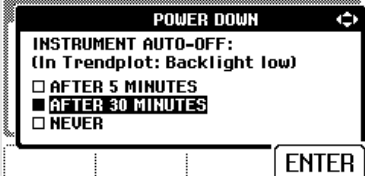
- ①  Open the USER OPTIONS menu.
- ②  Highlight POWER DOWN ...

- ③  Open the submenu.

- ④  Highlight AFTER 5 MIN.
- ⑤  Accept the new power down time.





Changing the Auto Set Options



Normally, the Auto Set function captures waveforms from 15 Hz.

To configure Auto Set for waveforms from 1 Hz with unchanged input coupling, do the following:

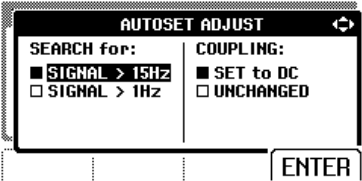
Note

Setting the Auto Set adjust to 1 Hz will slow down the Auto Set response.

①		Open the User Options menu.
②		Highlight AUTOSET ADJUST...
③		Open the AUTOSET ADJUST submenu.
		
④		Highlight SIGNALS > 1 Hz.
⑤		Select COUPLING.

⑥		Highlight UNCHANGED.
⑦		Accept the new Auto Set configuration.

Using Proper Grounding

Incorrect grounding can cause various problems. This Section gives you guidelines for proper grounding.

- Use the short ground lead(s) when measuring DC or AC signals on input A and input B. (See Figure 3-2.)

Warning

To avoid electrical shock or fire, use only one COM (common) connection, or ensure that all connections to COM are at the same potential.

- Use the unshielded black ground lead to COM (common) for Ohm (Ω), Continuity, Diode, and Capacitance measurements. (See Figure 3-3.)

Using the unshielded ground lead is also possible for single or dual input measurements for waveforms with a frequency up to 1 MHz. This may add some hum or noise to the waveform display due to the unshielded ground lead.

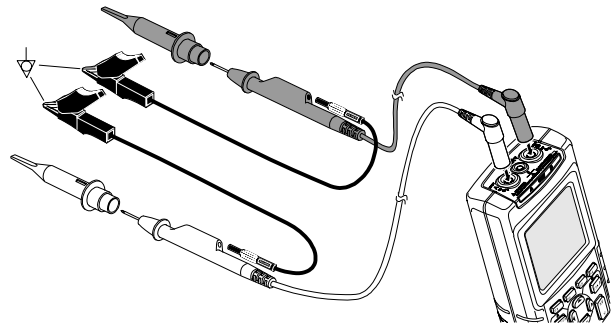

Figure 3-2. Grounding with Short Ground Lead

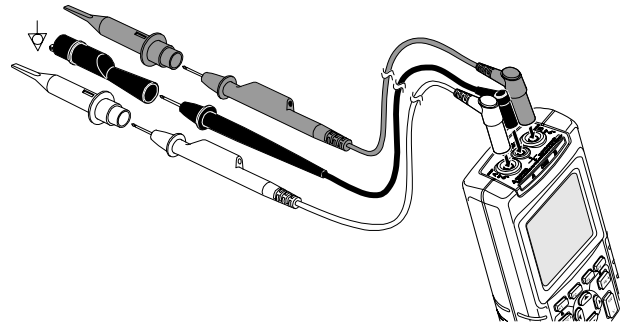

Figure 3-3. Grounding with Unshielded Ground Lead

Solving Printing and Other Communication Errors

RS-232 communication may cause problems. When experiencing communication problems, try the following remedies:

- Make sure that the interface cable is connected to the correct port on the printer or computer. If necessary use the 9 pin to 25 pin adapter or gender changer.
- Make sure that you have selected the correct printer type. (To select printer type, see Chapter 1.)
- Make sure that the baud rate matches with the printer or computer. (To set the baud rate, see Chapter 1.)
- Reset the RS-232 parameters to defaults.

Battery Testing of Fluke Accessories

When using battery operated Fluke accessories, always check the battery condition of the accessory first on a **Fluke multimeter** .

Chapter 4

Specifications

Introduction

Performance Characteristics

FLUKE guarantees the properties expressed in numerical values with the stated tolerance. Specified non-tolerance numerical values indicate those that could be nominally expected from the mean of a range of identical ScopeMeter test tools.

Environmental Data

The environmental data mentioned in this manual are based on the results of the manufacturer's verification procedures.

Safety Characteristics

The test tool has been designed and tested in accordance with Standards ANSI/ISA S82.01-1994, EN 61010.1 (1993) (IEC 1010-1), CAN/CSA-C22.2 No.1010.1-92 (including approval), UL3111-1 (including approval) Safety Requirements for Electrical Equipment for Measurement, Control, and Laboratory Use.

This manual contains information and warnings that must be followed by the user to ensure safe operation and to keep the instrument in a safe condition. Use of this equipment in a manner not specified by the manufacturer may impair protection provided by the equipment.

Dual Input Oscilloscope

Vertical

Frequency Response

DC Coupled:

excluding probes and test leads:	DC to 20 MHz (-3 dB)
with STL120 1:1 shielded test leads:	DC to 12.5 MHz (-3 dB)
	DC to 20 MHz (-6 dB)
with PM8918 10:1 probe (<i>optional accessory</i>):.....	DC to 20 MHz (-3 dB)

AC Coupled (LF roll off):

excluding probes and test leads	<10 Hz (-3 dB)
with STL120	<10 Hz (-3dB)
with PM8918.....	<1 Hz (-3 dB)

Rise Time

excluding probes and test leads	<17.5 ns
---------------------------------------	----------

Input Impedance

excluding probes and test leads	1 M Ω //12 pF
with BB120.....	1 M Ω //20 pF
with STL120.....	1 M Ω //225 pF
with PM8918	10 M Ω //15 pF

Sensitivity5 mV to 500 V/div

Display Modes A, -A, B, -B

Max. Input Voltage A and B

direct or with test leads	600 Vrms
with BB120.....	300 Vrms

(For detailed specifications, see "Safety")

Max. Floating Voltage

from any terminal to ground	600 Vrms
	up to 400 Hz

Resolution 8 bit

Vertical Accuracy $\pm(1\% + 0.05 \text{ range/div})$

Max. Vertical Move..... ± 4 divisions

Advanced Scope Functions

Display Modes

Normal Captures up to 40 ns glitches and displays analog-like persistence waveform.

Smooth Suppresses noise from a waveform.

Envelope ... Records and displays the minimum and maximum of waveforms over time.

Auto Set

Continuous fully automatic adjustment of amplitude, time base, trigger levels, trigger gap, and hold-off. Manual override by user adjustment of amplitude, time base, or trigger level.

Accuracy:
 @ 1 Hz to 1 MHz±(0.5% +2 counts)
 @ 1 MHz to 10 MHz±(1.0% +2 counts)
 @ 10 MHz to 40 MHz±(2.5% +2 counts)
 Full Scale Reading 10 000 counts

Duty Cycle (DUTY)

Range 2% to 98%
 Frequency Range in Continuous Autosest
 15 Hz (1 Hz) to 30 MHz

Accuracy:
 @ 1Hz to 1 MHz±(0.5% +2 counts)
 @ 1 MHz to 10 MHz±(1.0% +2 counts)
 @ 10 MHz to 40 MHz±(2.5% +2 counts)
 Resolution0.1%

Pulse Width (PULSE)

Frequency Range in Continuous Autosest
 15 Hz (1 Hz) to 30 MHz

Accuracy:
 @ 1 Hz to 1 MHz±(0.5% +2 counts)
 @ 1 MHz to 10 MHz±(1.0% +2 counts)
 @ 10 MHz to 40 MHz±(2.5% +2 counts)
 Full Scale Reading 1000 counts

Amperes (AMP)..... with optional current probe
 Ranges same as VDC, VAC, VAC+DC, or PEAK
 Scale Factor ... 1 mV/A, 10 mV/A, 100 mV/A, and 1 V/A
 Accuracy same as VDC, VAC, VAC+DC, or PEAK
 (add current probe uncertainty)

Temperature (TEMP).... with optional temperature probe
 Range 200 °C/div (200 °F/div)
 Scale Factor..... 1 mV/°C and 1 mV/°F
 Accuracy as VDC (add temp. probe uncertainty)

Decibel (dB)

0 dBV 1V
 0 dBm (600Ω /50Ω)..... 1 mW
 referenced to 600Ω or 50Ω
 dB onVDC, VAC, or VAC+DC
 Full Scale Reading 1000 counts

Crest Factor (CREST)

Range 1 to 10
 Accuracy ±(5% +1 count)
 Full Scale Reading 100 counts

Phase

Modes A to B, B to A
 Range0 to 359 degrees
 Accuracy ±(1 degree +1 count)
 Resolution 1 degree

Input A

Ohm (Ω)

Ranges500Ω, 5 kΩ, 50 kΩ, 500 kΩ, 5 MΩ, 30 MΩ
 Accuracy: ±(0.6% +5 counts)
 Full Scale Reading:
 500Ω to 5 MΩ 5000 counts
 30 MΩ 3000 counts

Miscellaneous

Display

Size72 x 72 mm (2.83 x 2.83 in)
Resolution 240 x 240 pixels
Waveform Display:
Vertical.....8 div of 20 pixels
Horizontal9.6 div of 25 pixels
Backlight..... Cold Cathode Fluorescent (CCFL)

⚠ Power

External:via Power Adapter PM8907
Input Voltage 10 to 21V DC
Power5W typical
Input Connector 5 mm jack
Internal:
Battery Power Rechargeable Ni-Cd 4.8V
Operating Time4 hours with bright backlight
5 hours with dimmed backlight
Charging Time 4 hours with test tool off
12 hours with test tool on
12 hours with refresh cycle
Allowable ambient temperature:
during charging 0 to 45 °C (32 to 113 °F)

Memory

Number of Screens2
Number of User Setups 10

Mechanical

Size.....232 x 115 x 50 mm (9.1 x 4.5 x 2 in)
Weight..... 1.1 kg (2.5 lbs)
including battery pack

Interface..... RS-232, optically isolated

To Printersupports Epson FX, LQ, and
HP Deskjet®, Laserjet®, and Postscript
Serial via PM9080 (optically isolated RS-232
adapter/cable, optional).
Parallel via PAC91 (optically isolated print adapter
cable, optional).
To PC..... Dump and load settings and data
Serial via PM9080 (optically isolated RS-232
adapter/cable, optional), using SW90W (FlukeView®
software for Windows®).

Environmental

EnvironmentalMIL 28800E, Type 3, Class III, Style B

Temperature

Operating 0 to 50 °C (32 to 122 °F)
Storage -20 to 60 °C (-4 to 140 °F)

Humidity

Operating:
 @0 to 10 °C (32 to 50 °F)noncondensing
 @10 to 30 °C (50 to 86 °F) 95%
 @30 to 40 °C (86 to 104 °F) 75%
 @40 to 50 °C (104 to 122 °F) 45%
 Storage:
 @-20 to 60 °C (-4 to 140 °F)noncondensing

Altitude

Operating 4.5 km (15 000 feet)
 Max. Input and Floating Voltage 600 Vrms upto 2 km,
 linearly derating to 400 Vrms @ 4.5 km
 Storage 12 km (40 000 feet)

Vibration max. 3g

Shock max. 30g

Electromagnetic Compatibility (EMC)

Emission EN 50081-1 (1992):
 EN55022 and EN60555-2

Immunity EN 50082-2 (1992):
 IEC1000-4-2, -3, -4, -5
 (See also Tables 1 to 3)

Enclosure Protection IP51, ref: IEC529

⚠ Safety

Designed for measurements on 600 Vrms Category III Installations, Pollution Degree 2, per:

- ANSI/ISA S82.01-1994
- EN61010-1 (1993) (IEC1010-1)
- CAN/CSA-C22.2 No.1010.1-92 (including approval)
- UL3111-1 (including approval)

⚠ Max. Input Voltage Input A and B

Direct on input or with leads 600 Vrms
for derating, see Figure 4-1.
With Banana-to BNC Adapter BB120 300 Vrms
for derating, see Figure 4-1.

⚠ Max. Floating Voltage

from any terminal to ground 600 Vrms
up to 400 Hz

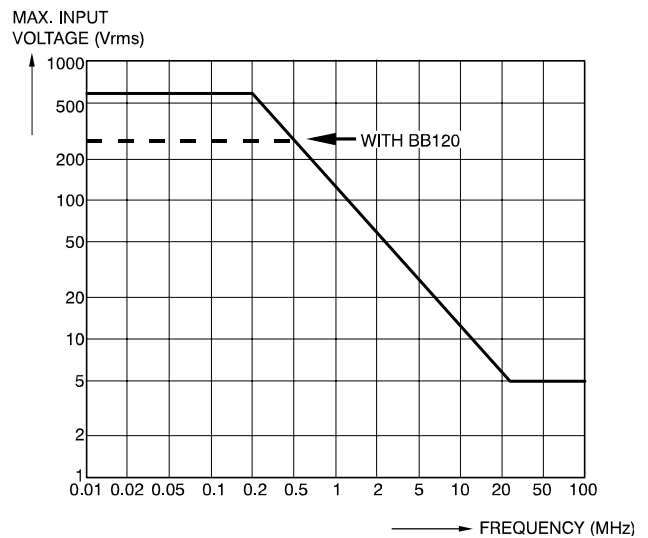

Figure 4-1. Max. Input Voltage v.s. Frequency

The Fluke 123, including standard accessories, conforms with the EEC directive 89/336 for EMC immunity, as defined by IEC1000-4-3, with the addition of the following tables.

Trace disturbance with STL120

Table 1

No visible disturbance	E= 3 V/m	E= 10 V/m
Frequency range 10 kHz to 27 MHz Frequency range 27 MHz to 1 GHz	50 mV/div to 500 V/div 50 mV/div to 500 V/div	500 mV/div to 500 V/div 50 mV/div to 500 V/div

Table 2

Disturbance less than 10% of full scale	E= 3 V/m	E= 10 V/m
Frequency range 10 kHz to 27 MHz Frequency range 27 MHz to 1 GHz	10 mV/div to 20 mV/div 5 mV/div to 20 mV/div	50 mV/div to 200 mV/div -

(-): no visible disturbance

Test tool ranges not specified in tables 1 and 2 may have a disturbance of more than 10% of full scale.

Multimeter disturbance:

- VDC, VAC, and VAC+DC with STL120 and short ground lead.
- OHM, CONT, DIODE, and CAP with STL120, and black test lead to COM.

Table 3

Disturbance less than 1% of full scale	E= 3 V/m	E= 10 V/m
Frequency range 10 kHz to 27 MHz VDC, VAC, VAC+DC OHM, CONT, DIODE CAP	500 mV to 1250V 500Ω to 30 MΩ 50 nF to 500 μF	500 mV to 1250V 500Ω to 30 MΩ 50 nF to 500 μF
Frequency range 27 MHz to 1 GHz VDC, VAC, VAC+DC OHM, CONT, DIODE CAP	500 mV to 1250V 500Ω to 30 MΩ 50 nF to 500 μF	500 mV to 1250V 500Ω to 30 MΩ 50 nF to 500 μF

Test tool ranges not specified in table 3 may have a disturbance of more than 10% of full scale.

Index

—A—

AC120 Alligator Clips, 44
Accessories, 43
AC-Coupling, 26
Acquiring the Waveform, 23
Acquisition Modes, 57
Adjusting Scope Probes, 41
Advanced Meter Functions, 61
Advanced Scope Functions, 58
Alligator Clips, 2, 44
Altitude, 63
Ampere Measurement, 60
Amplitude, 18
Auto Set, 13, 58
Auto Set Configuration, 52

Automatic Power Shutdown, 51
Avoid Electrical Shock, 12

—B—

Backlight, 9
Banana Jack Inputs, 12
Banana-to-BNC Adapter, 2, 44
Bandwidth, 56
Battery Charger, 2, 44
Battery Disposing, 40
Battery Indicator, 10
Battery Life, 51
Battery Pack, 2, 38, 44
Battery Power, 62
Battery Refresh, 39
Battery Refresh Date, 43

Battery Replacing, 40
BB120 Adapters, 44
Blue Function Keys, 10
BP120 Battery Pack, 2, 41, 44
Bright Display, 9

—C—

C120 Hard Case, 2, 46
C789 Soft Case, 46
Calibrating the Test Tool, 43
Capacitance, 14, 53, 61
Changing the Amplitude, 18
Changing the Display, 49
Changing the Graphic Representation, 18
Changing the Time Base, 18

Charge Time, 62
Charger, 44
Charging, 38
Cleaning, 37
Common, 5, 12
Communication Errors, 54
Computer, 36
Connect-and-View function, 13
Connecting a Computer, 36
Continuity, 14, 53, 61
Contrast, 49
Crest Factor, 60
Current Measurement, 60

—D—

Date, 50
DC Voltage (VDC), 59
Decibel (dB), 60
Declaration of Conformity, 1
Deleting Screens, 33
Dimmed Display, 9
Diode, 14, 53, 61
Display, 49, 62
Disposing Batteries, 40
Duty Cycle, 60

—E—

Earth Ground, 5
Electrical Shock, 5
Electrically Floating, 5
Electromagnetic Compatibility, 1, 63
Emission, 63
Envelope, 58
Envelope of a Waveform, 21
Environmental, 63
Environmental Data, 55

—F—

Fast/Smooth, 61
Fixed Decimal Point, 61
FlukeView, 2, 36, 46
Freeze Recording, 25
Freezing the Screen, 16
Frequency (Hz), 59
Frequency Response, 56
Function Keys, 10

—G—

Glitch Detection, 57
Graphic Representation, 18

Gray Text, 28
Grey INPUT B, 12
Grid Display, 49
Ground, 5
Ground Test Lead, 2, 44
Grounding Problems, 53

—H—

Hands-Free Measurements, 16
Hard Carrying Case, 2, 46
HC120 Hook Clips, 44
Holding a Stable Reading, 16
Hook Clips, 2, 44
Horizontal Move, 57
Humidity, 63
Hz, 59

—I—

Immunity, 63
Information Language, 48
Input A, 12
Input B, 12
Input Impedance, 56
Isolated, 5
Isolated Trigger Probe, 29, 46
Isolated Triggering, 29

ITP120, 29, 46

—L—Language, 48
Level, 27**—M—**Maintenance, 37
Making Measurements, 14
Manual, 45
Manual Override, 58
Max. Floating Voltage, 56, 64
Max. Input Voltage, 56, 64
Maximum (MAX) Reading, 23
Measurement Connections, 12
Measurements, 14
Mechanical, 62
Memory, 62
Memory Location, 33
Menu Area, 10
Meter A Measurement, 14
Meter B Measurement, 15
Min Max Reading, 23
Minimum (MIN) Reading, 22
Multimeter Disturbance, 66**—N—**

Ni-Cd Battery Pack, 2, 38, 44

—O—Ohm (Ω), 14, 53, 60
Operating Time, 62
Optical Interface, 34, 36, 62**—P—**PAC91, 46
Parallel Print Cable, 46
Parts, 43
Peak, 59
Performance Characteristics, 55
Phase, 60
PM8907, 44
PM8918 Probe, 41, 46, 56
PM9080, 34, 36, 46
Polarity, 26
Positioning the Waveform, 19
Power Adapter, 2, 44, 51
Power Down Timer, 51
Powering the Test Tool, 7
Print Cable, 46
Printing, 34Printing Errors, 54
Probe, 41, 46, 56
Product Registration Card, 2
Pulse Width, 60**—R—**Reading Area, 10, 14
Reading the Screen, 10
Recalibrating, 43
Recalling, 32
Recalling Screens, 33
Record a Waveform, 21
Recording Slow Signals, 25
Red INPUT A, 12
Refreshing the Batteries, 39, 43
Relative Measurements, 17
Replaceable Parts, 43
Replacing Batteries, 40
Resetting, 48
Resetting the Test Tool, 8
Reversing the Polarity, 26
Rise Time, 56
Roll Mode Function, 25
RS-232 Adapter/Cable, 2, 34, 36,
46
RS-232 Communication Errors, 54

—S—

Safety, 64
Safety Characteristics, 55
Safety Precautions, 4
Safety Requirements, 1
Sampling Rate, 57
Saving, 32
Saving Screens, 32
SCC 120, 36, 46
Scope Modes, 57
Scope Probes, 41, 46, 56
Screen Contrast, 49
Selecting Trigger Parameters, 28
Sensitivity, 56
Serial Printer, 34
Service Manual, 43
Shielded Test Leads, 2, 44
Shock, 63
Single Shot, 23
Slope, 27, 57
Slow Signals, 25
Smooth, 20, 58
Soft Carrying Case, 46
Software, 46
Software Version, 43

Specifications, 55
Stable Reading, 16
Stand, 47
STL120 Test Leads, 44
Storing, 37
SW90W Software, 2, 36, 46

—T—

Temperature, Environmental, 63
Temperature Measurement, 60
Test Leads, 44
Tilt Stand, 47
Time, 50
Time Base, 18
Time Base Accuracy, 57
Time Base Ranges, 57
Touch Hold® function, 16, 61
Trace Disturbance, 65
TrendPlot™ Function, 22, 61
Trigger, 57
Trigger Icons, 27
Trigger Level, 27
Trigger Parameters, 28
Trigger Sensitivity, 57
Triggering, 27

—U—

Unpacking, 2
User Manual, 45
Users Manual, 2
Using a Printer, 34
Using FlukeView Software, 36

—V—

Vertical Accuracy, 56
Vibration, 63
Video Line, 31
Video on A, 57
Video Signals, 29

—W—

Waveform Area, 10

—Z—

Zero Reference, 17